

Electrochemical behaviour of pure iron in the aluminium refining electrolyte

J. CHRYSSOULAKIS, J. BOUTEILLON, J. C. POIGNET

Laboratoire d'Energétique Electrochimique Associé au C.N.R.S. (L.A. 265), E.N.S. d'Electrochimie et d'Electrometallurgie, B.P. 44 Domaine Universitaire, 38401 Saint-Martin d'Herès, France

Received 17 May 1977

The reduction of iron dissolved in the aluminum refining industrial melt was studied using cyclic voltammetry and chronopotentiometry. The required solutions were obtained by adding ferrous or ferric fluoride to the Gadeau electrolyte. The experimental arrangement permitted molten fluoride electrolysis as well as the introduction of additional salts under an inert argon atmosphere. Platinum, iron and graphite electrodes were used. Chemical analysis proved that the stable ionic valency of iron in the melt at 750° C was II. The reduction reaction of the Fe(II) ions was reversible and involved two electrons. The diffusion coefficient of the Fe(II) ions was calculated.

1. Introduction

Aluminium taken out of the electrolysis cells contains iron (0.2%) as the main impurity. It needs to be electrolytically refined for some applications.

We first investigated the electrochemical behaviour of copper [1] which is mixed with impure aluminium to increase the density of the anode in the industrial refining process, and then we focussed our interest on the electrochemical behaviour of iron in the refining electrolyte.

Papers concerning the electrochemical behaviour of iron in molten fluorides are scarce [2–12] and their results can hardly be transposed to the industrial refining melt which has a more complex molar composition (NaF: AlF₃: BaCl₂ – 1.48: 1.0: 1.05).

Grjotheim [3] found, in molten NaF–KF at 850° C, that the equilibrium potential of the Fe/Fe(III) couple was equal to –0.12 V with respect to the Ni/Ni(II) electrode.

Delimarskii *et al.* [4] also assigned the III valency to iron ions present in several molten fluoride mixtures, between 700° C and 1000° C: using polarography at a platinum electrode, they found that the number of electrons exchanged in the reduction reaction was three.

On the other hand, Manning [5] concluded that for molten LiF–NaF–KF between 470° C and

545° C the reduction of anodically generated iron ions involved two electrons. Manning and Mamantov [6, 7] studied the reduction of Fe(II) ions to Fe and the oxidation of these ions to Fe(III) ions for LiF–NaF–KF and for molten LiF–BeF₂ at 507° C. They found that the stable valency was II.

More recently Pizzini *et al.* [10] studied the electrochemical behaviour of iron in the eutectic mixture LiF–NaF–KF between 500° C and 700° C, using galvanostatic and potentiostatic methods. According to them the concentration of Fe(III) is very low, when iron is present, because the equilibrium

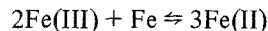

is shifted to the right.

In the present work, after the experimental section, we shall try to specify the oxidation number of the iron ions present in molten NaF–AlF₃–BaCl₂, the mechanism and reversibility of the electron exchange between these ions and the metal, and finally we shall estimate their diffusion coefficient.

2. Experimental

2.1. Chemical products

The preparation and the limiting electrode reactions of the solvent have been previously reported

[1]. Ferrous fluoride (Koch light 94%) or ferric fluoride (Koch light 98%) were added to the solvent, without any further treatment, in order to prepare the required solutions.

2.2. Electrodes

The graphite, platinum or iron working electrodes were rectangular, with geometrical areas between 2.2 cm² and 3.3 cm². The vitreous carbon (carbone Lorraine V10) counter electrode was a rectangular sheet with an area approximately equal to 4 cm². The reference electrode, based on the Ag⁺/Ag system [1], was constituted by the following half cell

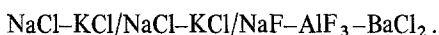

2.3. Electrolysis cell

The cell used for the voltammetric and preliminary chronopotentiometric studies has already been described in a paper about the behaviour of copper [1] in the same melt but, as the presence of traces of oxygen affected the chronopotentiograms, we decided to perform the chronopotentiometric studies in the oxygen-free cell described below.

The electrolyte was contained in a cylindrical crucible (65 mm internal diameter, 70 mm long), made of carbone Lorraine V10 vitreous carbon, and situated inside a gas-tight container (Fig. 1). This container essentially comprised two parts: the cylindrical tube G, which held the electrolysis crucible; and the head, on which several systems were fixed – electrode holders, thermocouple sheaths and an air-lock chamber for the introduction of additional salts.

The tube G, made of NS30 refractory stainless steel had an internal diameter of 80 mm and was 330 mm long. It was closed at its bottom. At its top, a clamp (Br) fitted with a viton O ring ensured the air-tight assembly between the tube itself and the head (Te). Purified argon was blown either through the lock chamber (S) or through the electrolysis cell, and was let out via a washbottle filled with H₂SO₄.

The head, made of stainless NS30 steel, was water-cooled and provided with several air-tight holders. Cylinder-piston arrangements allowed rotational and translational motions through each

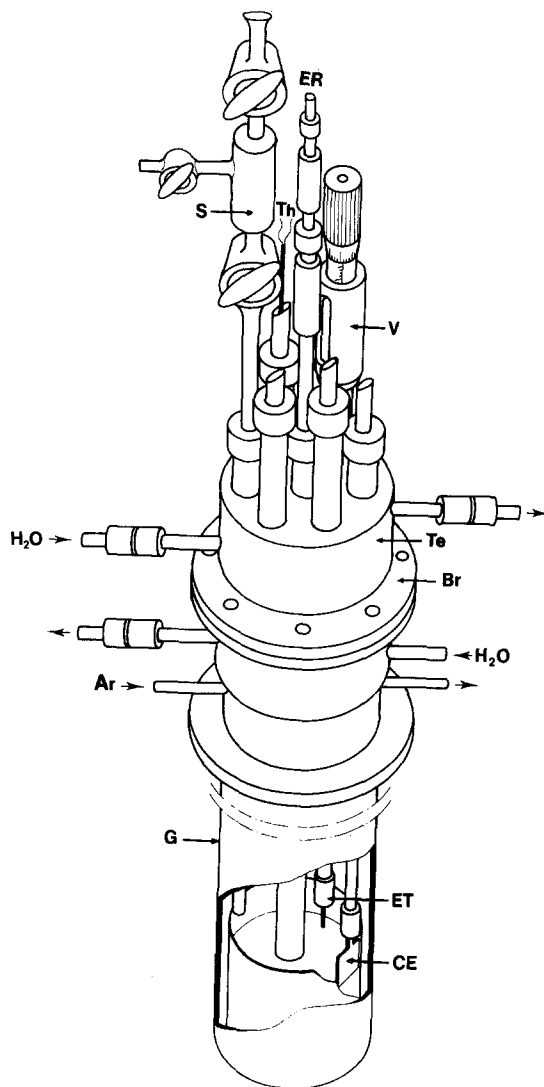

Fig. 1. Electrolysis cell.

holder. Air-tightness, at this level, was ensured by means of O rings fitted in grooves worked in the inner walls of the cylinders. Electrical insulation from the metallic parts of the holders was achieved by means of olive shaped teflon 'Gyrolok' joints. These devices permitted the motions or the securing of several tubes, which held the counterelectrode (CE), the reference electrode (ER), the thermocouple sheath (Th), and the lock chamber (S), for the introduction of addition salts.

For each experiment the vitreous carbon crucible, filled with the electrolyte, was inserted at the bottom of tube G.

The tube and head were then assembled, and

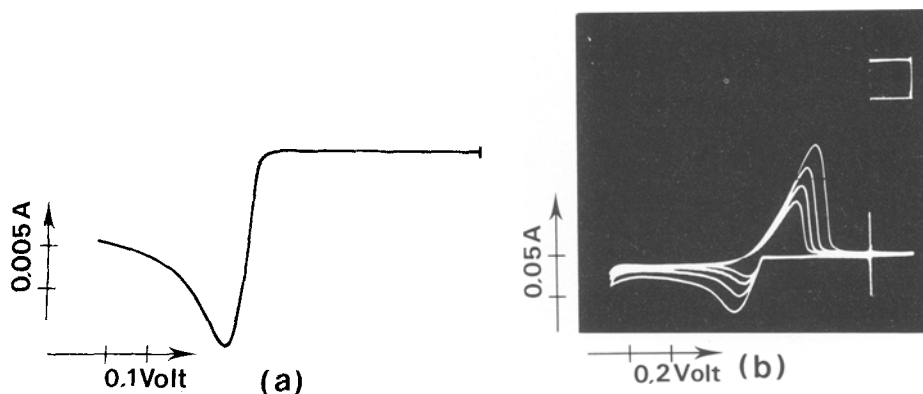

Fig. 2. Voltammetric reduction of iron ions at a graphite electrode: (a) $C_{\text{Fe(II)}} = 10.9 \times 10^{-5} \text{ mol cm}^{-3}$, sweep rate = 1 V s^{-1} , $e_{i=0} = -0.01 \text{ V}$ vs. the reference electrode;

(b) $C_{\text{Fe(II)}} = 10.9 \times 10^{-5} \text{ mol cm}^{-3}$, sweep rates = 1, 2, 4 and 8 V s^{-1} , $e_{i=0} = 0 \text{ V}$ vs. the reference electrode.

argon was circulated for 12 to 15 h. The salt was then heated and melted. The electrodes, previously mounted on the holding device, were slid down into the electrolyte and a weighed amount of ferrous or ferric fluoride was added to the melt. An argon atmosphere was maintained throughout the experiment.

2.4. Electric circuit

The voltammetric and the chronopotentiometric circuits have already been described [1, 13].

3. Voltammetric study of the reaction $\text{Fe(II)} + 2e \rightleftharpoons \text{Fe}$

We recorded voltammetric curves $I-e$ at a graphite or iron electrode, in solutions containing $10^{-5} \text{ mol cm}^{-3}$ to $10^{-4} \text{ mol cm}^{-3}$ ferrous fluoride, for various values of the voltage sweep rate.

Fig. 2(a) shows such a curve for a sweep rate equal to 1 V s^{-1} and a concentration $C_{\text{Fe(II)}} = 10.9 \times 10^{-5} \text{ mol cm}^{-3}$, at a graphite electrode. We can observe a peak corresponding to the reduction of iron ions, situated at a potential $e_p = -0.63 \pm 0.04 \text{ V}$ (vs. reference electrode), which is about 80 mV more cathodic than that obtained for the reduction of Cu(I) ions at a graphite electrode, under the same experimental conditions [1].

The shape of the cathodic peak obtained at a graphite electrode is typical [14] of a reversible reaction with formation of an insoluble deposit (Fig. 2).

The uncertainty of the peak and half-peak volt-

age determinations, which is about 5 mV, is too high for the number of electrons exchanged to be accurately calculated by this method. A different method, chronopotentiometry, was therefore used for this purpose.

4. Chronopotentiometric study of the reduction of iron ions

Fig. 3 (a, b and c) shows chronopotentiograms obtained at graphite, platinum and iron electrodes, in a solution containing $8.67 \times 10^{-5} \text{ mol cm}^{-3}$ of ferric fluorides.

A single transition was observed, for each type of electrode. The transition times were determined according to Reinmuth's method [15].

The voltage step at the origin of the chronopotentiograms, for graphite and iron electrodes, was assigned to the ohmic drop in the electrolyte, which remained constant along the curve.

The overvoltage $e_{\tau/4}$ (τ is transition time), when corrected for ohmic drop, in the case of the graphite electrode, did not depend on the current density. Its experimental value, equal to $-0.027 \pm 0.002 \text{ V}$, could be compared to that calculated (-0.0305 V [14]) for a reversible exchange of two electrons at 750° C .

This value was in good agreement with that obtained in the case of the iron electrode ($e_{\tau/4} = -0.028 \pm 0.002 \text{ V}$).

In the case of platinum electrodes, the activity of the reduced species changed as the deposition was proceeding, which affected the $e_{\tau/4}$ value. We also noticed a similar phenomenon when studying

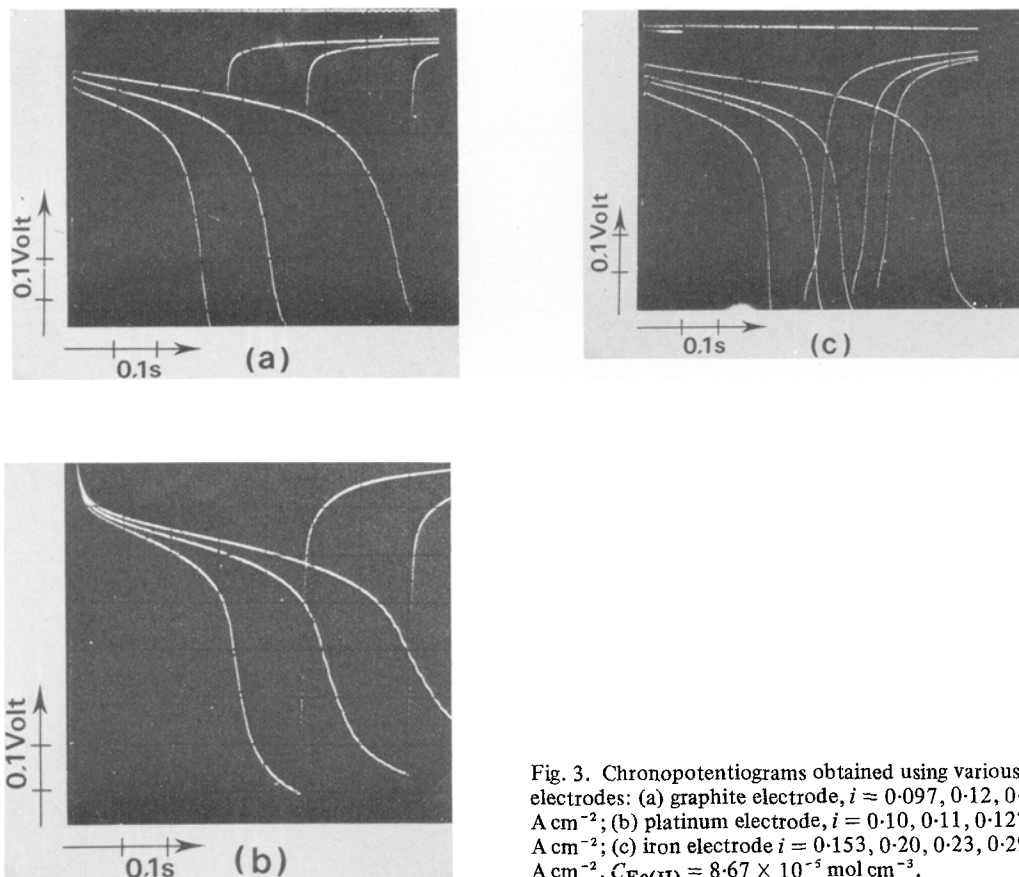

Fig. 3. Chronopotentiograms obtained using various electrodes: (a) graphite electrode, $i = 0.097, 0.12, 0.145$ A cm^{-2} ; (b) platinum electrode, $i = 0.10, 0.11, 0.127$ A cm^{-2} ; (c) iron electrode $i = 0.153, 0.20, 0.23, 0.29$ A cm^{-2} . $C_{\text{Fe(II)}} = 8.67 \times 10^{-5}$ mol cm^{-3} .

the reduction of copper [1] and manganese ions at a platinum electrode.

Fig. 4 (a, b and c) shows the variations of the potential of the working electrodes as a function of $\log_{10} (\sqrt{\tau} - \sqrt{t})/\sqrt{\tau}$ and $\log_{10} (\sqrt{\tau} - \sqrt{t})/\sqrt{t}$ (t is time).

In the case of graphite and iron electrodes, the reduced species was insoluble, since then $e = f[\log_{10} (\sqrt{\tau} - \sqrt{t})/\sqrt{\tau}]$ plots were linear. The slopes of these straight lines (0.092 V decade^{-1} for graphite and 0.11 Volt decade^{-1} for iron) yielded the value of the number of electrons (n) exchanged, $n = 2 \pm 0.2$. The $e = f[\log_{10} (\sqrt{\tau} - \sqrt{t})/\sqrt{t}]$ plot was linear in the case of the platinum electrode. We think that the reduced species dissolved in platinum as it was produced. However, the value of the number of exchanged electrons, $n = 2.5$, calculated from the slope of the curve, is not in agreement with the values obtained with graphite and iron electrodes. This may be due to partial solubility of iron in platinum.

5. Determination of the stable ionic iron valency and diffusion coefficient of the corresponding iron species

The value of the oxidation state of iron ions in fluoride electrolytes, at temperatures between 470°C and 1000°C , does not come out clearly from the literature. We therefore elucidated this question in the case of the $\text{NaF-AlF}_3\text{-BaCl}_2$ electrolyte by some qualitative and quantitative observations: 20 g of this electrolyte, containing a known quantity of ferrous or ferric fluoride, was melted and maintained at 700°C for about half an hour, then quickly cooled and dissolved in water. Ortho-phenanthroline tests showed the presence of ferrous ions in the solution and, in all cases, titration with a permanganate solution proved that it appeared that all of the iron species were in the form of ferrous ions. We demonstrated that, when ferric ions were added to the solvent, they underwent a reduction reaction. Argon was blown over the melt-

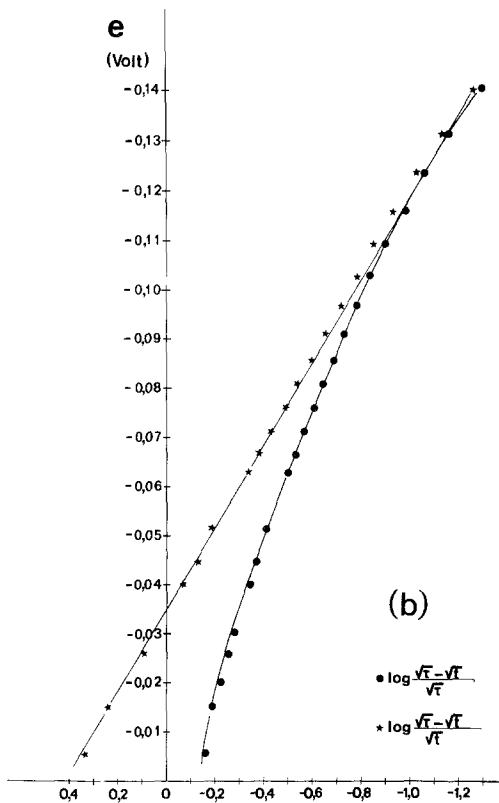
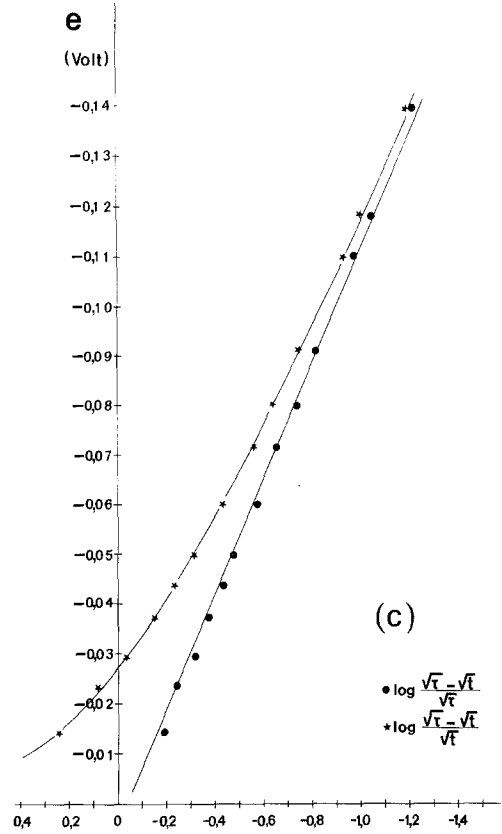
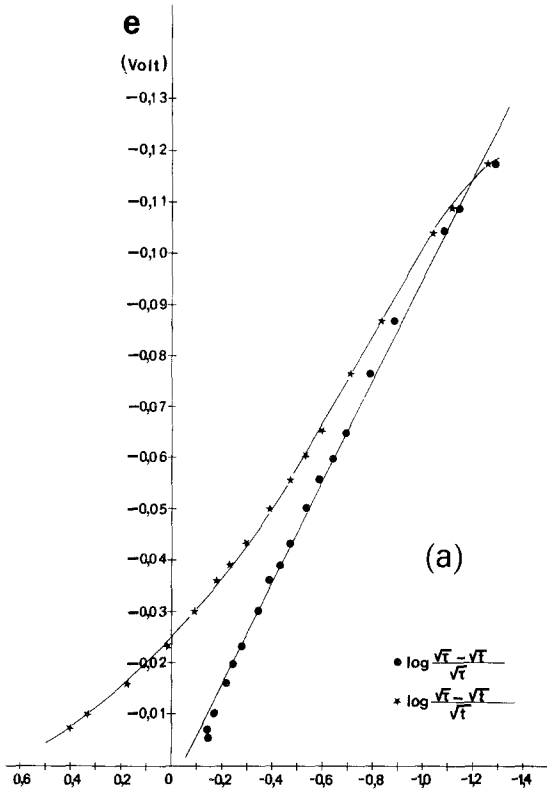
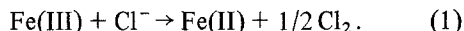

Fig. 4(a) Graphite electrode, $C_{Fe(II)} = 2.63 \times 10^{-5} \text{ mol cm}^{-3}$; (b) Platinum electrode, $C_{Fe(II)} = 8.67 \times 10^{-5} \text{ mol cm}^{-3}$; (c) Iron electrode, $C_{Fe(II)} = 7.89 \times 10^{-5} \text{ mol cm}^{-3}$.

ing mixture previously evacuated, and bubbled through a KI solution which was oxidized to produce I_2 . We observed also that the vapours over the melt were able to oxidize the Villiers reagent which indicated the presence of chlorine. Addition of ferrous ions to the melt was not followed by any chlorine evolution.

Iron ions are therefore present mainly as ferrous ions, because of the reaction



This valency is in agreement with our chronopotentiometric determinations. Finally, using the mean value of the constant $i\sqrt{\tau}/C = 880 \pm 60 \text{ A s}^{1/2}$ cm mol (C is concentration of Fe(II) ions) deduced from the chronopotentiograms, we calculated the value of the diffusion coefficient (D) of the ferrous ions, $D_{\text{Fe(II)}} = (2.8 \pm 0.2) \times 10^{-5} \text{ cm}^2 \text{ s}^{-1}$.

This value is of the same order as that found for ferrous ions in a different fluoride melt [17].

6. Conclusions

In the aluminium refining electrolyte NaF–AlF₃–BaCl₂, the stable ionic iron species is Fe(II), because of Reaction 1.

The mechanism of the Fe(II)/Fe exchange is reversible and corresponded to the exchange of two electrons.

The diffusion coefficient of the Fe(II) species is $D_{\text{Fe(II)}} = (2.8 \pm 0.2) \times 10^{-5} \text{ cm}^2 \text{ s}^{-1}$.

Acknowledgement

The authors are indebted to Mr René Faure for technical assistance.

References

- [1] J. Chryssoulakis, J. De Lepinay and M. J. Barbier, *J. Appl. Electrochem.* **6** (1976) 507.
- [2] G. Grube and P. Hantelmann, *Z. Elektrochem.* **66** (1952) 1.
- [3] K. Grjotheim, *Z. F. Phys. Chem. Neue Folge* **11** (1957) 150.
- [4] Yu. K. Delimarskii and B. F. Markov, 'Electrochemistry of Fused Salts', Sigma Press, Washington DC (1961) 186.
- [5] D. L. Manning, *J. Electroanal. Chem.* **6** (1963) 227.
- [6] D. L. Manning and G. Mamantov, *ibid.* **7** (1964) 102.
- [7] G. Mamantov, D. L. Manning and J. M. Dale, *ibid.*
- [8] S. Senderoff, *Met. Rev.* **11** (1966) 97.
- [9] Yu. K. Delimarskii and N. A. Pavlenko, *Ukrain. khim. Zhur.* **33** (1967) 130.
- [10] S. Pizzini, E. Roemer and R. Morlotti, *Electrochim. Metall. III* **2** (1968) 151.
- [11] Yu. K. Delimarskii, *Ukrain. khim. Zhur.* **35** (1969) 12.
- [12] H. W. Jenkins, G. Mamantov and D. L. Manning, *J. Electrochem. Soc.* **117** (1970) 183.
- [13] J. C. Poignet and M. J. Barbier, *Electrochim. Acta* **17** (1972) 1227.
- [14] P. Delahay, 'New Instrumental Methods in Electrochemistry', Interscience, New York (1965).
- [15] W. H. Reinmuth, *Anal. Chem.* **33** (1961) 485.
- [16] J. Chryssoulakis, Thèse (Grenoble), Février 1977.
- [17] Janaf, Thermochemical Tables (second edition), Nat. Stand. Ref. Data Ser., Nat. Bur. Stand (US) **37** (1971).